

Piattaforma autocentrante idraulica Ø1400 ÷ Ø6000

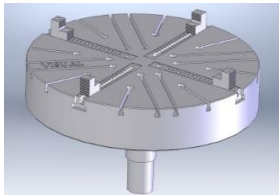

Piattaforma manuale Ø1400 ÷ Ø6000

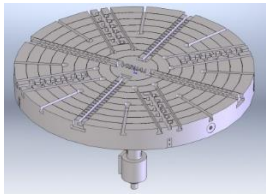

Pallet fisso per fresatura

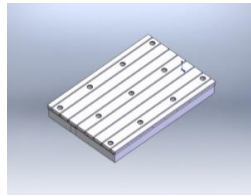

Pallet fisso per fresatura e tavola

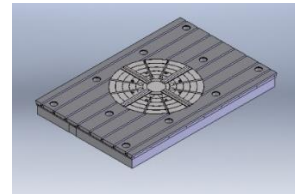

Tornio monomandrino

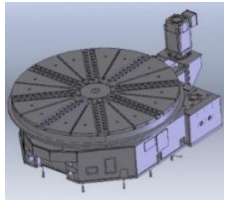

Tornio bimandrino

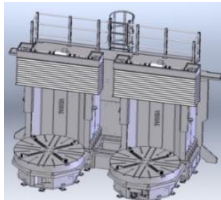

Tornio gantry

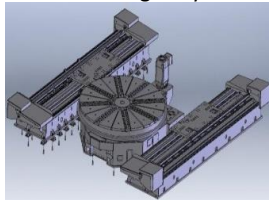

Fresatrice gantry

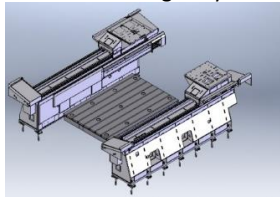

Fresatrice gantry con tavola

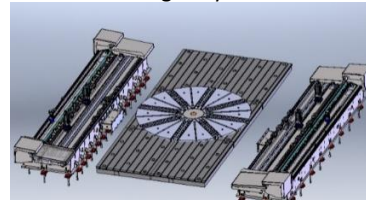

Asse "C"

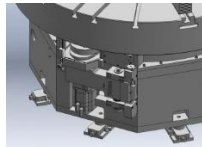

Traversa fissa

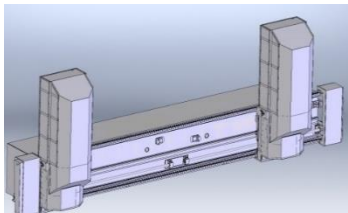

Traversa mobile

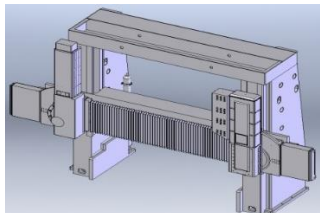

Carro singolo



Carro doppio

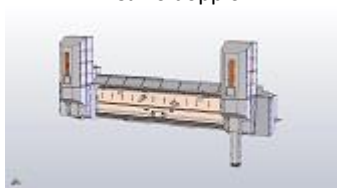

Ram di tornitura



200x200 mm

Ram di tornitura e fresatura senza cambio gamma



200x200 mm

Ram di tornitura e fresatura con cambio gamma

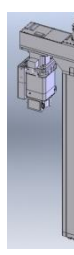

350x350 mm

Ram di fresatura con asse C



Testa revolver



Magazzino ISO50

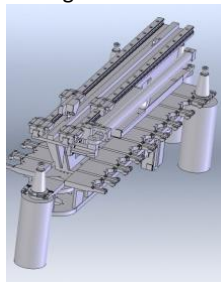

Magazzino 12 torrette

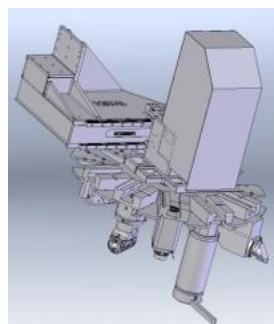

Magazzino ISO50/Capto con navetta porta pinze e teste

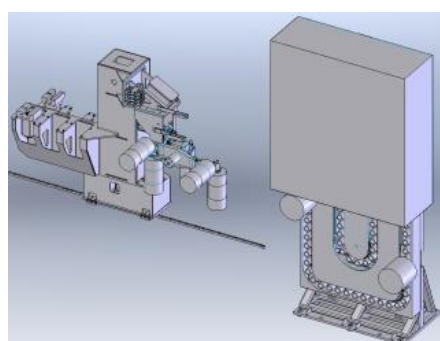

Testa fissa

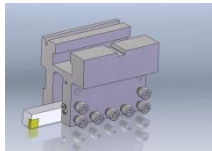

Testa C6/C8

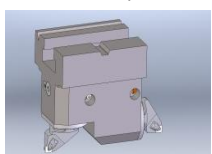

Testa porta bareno



Testa fissa

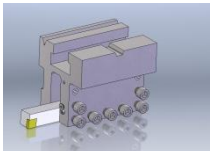

Testa C6/C8

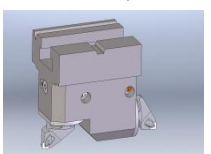

Testa porta bareno



Mandrino verticale



Mandrino orizzontale

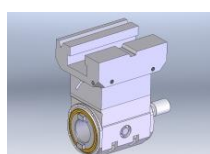

Testa manuale

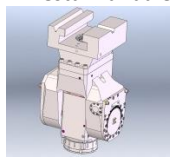

Testa automatica



Testa tornitura

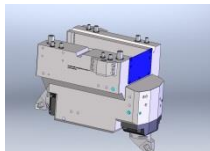

Mandrino verticale

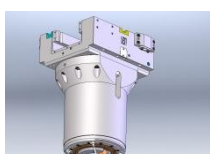

Mandrino orizzontale

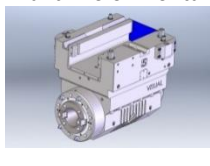

Testa automatica

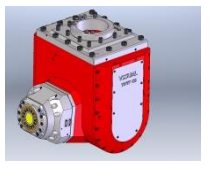

Testa bimandrino



Testa high-power



Testa high-speed

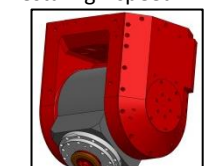

Testa universale

